

ROURA

Distributed By:
Solution Dynamics Inc
877-860-3620

BEHEMOTH HOPPER MODEL

5T-1/4-EL-2430 9 CU YD



MODEL#	VOLUME	L	W	H	WEIGHT	FORK OPENING	MAX LOAD CAP
5T-1/4-EL-2430	9 Yd ³	91"	122"	70"	2820 LBS	3" X 61-1/2"	10000 LBS

BEHEMOTH 5T-1/4-EL-2430

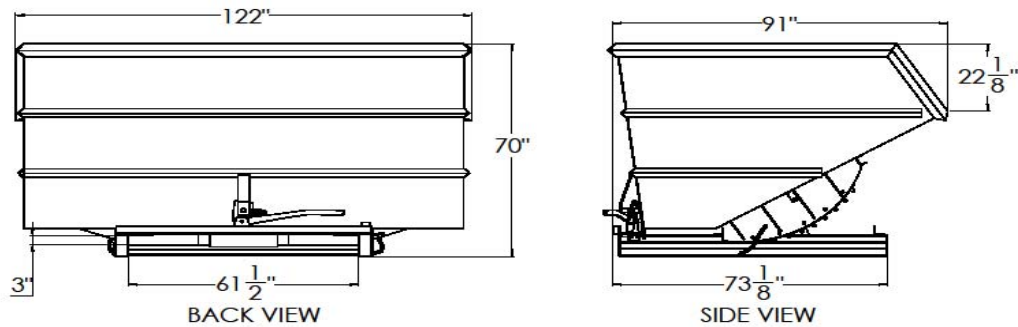

CONSTRUCTION: 3/16" plate body, reinforced with 3 additional rows of reinforcing angle, 5/16" heavy duty boxed tube base, extended steel handle with secure flip latch, base to body chains, slide bolt latch and continuous stops.

FINISH: Bright safety green enamel paint.

OPTIONAL ITEMS ARE AVAILABLE

(STEEL COVER & CASTERS ARE NOT AVAILABLE ON ANY BEHEMOTH HOPPER MODELS)

"FOR ALL YOUR MATERIAL HANDLING NEEDS!"